

IRG4IBC20FDPbF

INSULATED GATE BIPOLAR TRANSISTOR WITH
ULTRAFAST SOFT RECOVERY DIODE

Fast CoPack IGBT

Features

- Very Low 1.66V voltage drop
- 2.5kV, 60s insulation voltage ⑤
- 4.8 mm creepage distance to heatsink
- Fast: Optimized for medium operating frequencies (1-5 kHz in hard switching, >20 kHz in resonant mode).
- IGBT co-packaged with HEXFRED™ ultrafast, ultrasoft recovery antiparallel diodes
- Tighter parameter distribution
- Industry standard Isolated TO-220 Fullpak™ outline
- Lead-Free

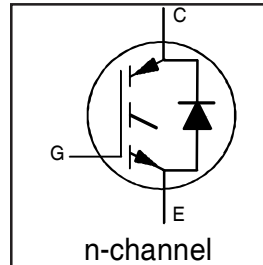

$V_{CES} = 600V$
$V_{CE(on) typ.} = 1.66V$
@ $V_{GE} = 15V, I_C = 9.0A$

Benefits

- Simplified assembly
- Highest efficiency and power density
- HEXFRED™ antiparallel Diode minimizes switching losses and EMI

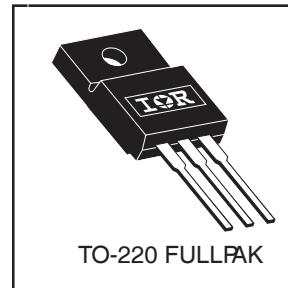

Absolute Maximum Ratings

	Parameter	Max.	Units
V_{CES}	Collector-to-Emitter Voltage	600	V
$I_C @ T_C = 25^\circ C$	Continuous Collector Current	14.3	A
$I_C @ T_C = 100^\circ C$	Continuous Collector Current	7.7	
I_{CM}	Pulsed Collector Current ①	64	
I_{LM}	Clamped Inductive Load Current ②	64	
$I_F @ T_C = 100^\circ C$	Diode Continuous Forward Current	6.5	
I_{FM}	Diode Maximum Forward Current	64	
Visol	RMS Isolation Voltage, Terminal to Case③	2500	V
V_{GE}	Gate-to-Emitter Voltage	± 20	
$P_D @ T_C = 25^\circ C$	Maximum Power Dissipation	34	W
$P_D @ T_C = 100^\circ C$	Maximum Power Dissipation	14	
T_J	Operating Junction and	-55 to +150	°C
T_{STG}	Storage Temperature Range		
	Soldering Temperature, for 10 sec.	300 (0.063 in. (1.6mm) from case)	
	Mounting Torque, 6-32 or M3 Screw.	10 lbf•in (1.1 N•m)	

Thermal Resistance

	Parameter	Typ.	Max.	Units
$R_{\theta JC}$	Junction-to-Case - IGBT	—	3.7	°C/W
$R_{\theta JC}$	Junction-to-Case - Diode	—	5.1	
$R_{\theta JA}$	Junction-to-Ambient, typical socket mount	—	65	
Wt	Weight	2.0 (0.07)	—	g (oz)

Electrical Characteristics @ T_J = 25°C (unless otherwise specified)

	Parameter	Min.	Typ.	Max.	Units	Conditions
V _{(BR)CES}	Collector-to-Emitter Breakdown Voltage ^③	600	—	—	V	V _{GE} = 0V, I _C = 250μA
ΔV _{(BR)CES/ΔT_J}	Temperature Coeff. of Breakdown Voltage	—	0.72	—	V/°C	V _{GE} = 0V, I _C = 1.0mA
V _{CE(on)}	Collector-to-Emitter Saturation Voltage	—	1.66	2.0	V	I _C = 9.0A
		—	2.06	—		I _C = 16A
		—	1.76	—		I _C = 9.0A, T _J = 150°C
V _{GE(th)}	Gate Threshold Voltage	3.0	—	6.0		V _{CE} = V _{GE} , I _C = 250μA
ΔV _{GE(th)/ΔT_J}	Temperature Coeff. of Threshold Voltage	—	-11	—	mV/°C	V _{CE} = V _{GE} , I _C = 250μA
g _{fe}	Forward Transconductance ^④	2.9	5.1	—	S	V _{CE} = 100V, I _C = 9.0A
I _{CES}	Zero Gate Voltage Collector Current	—	—	250	μA	V _{GE} = 0V, V _{CE} = 600V
		—	—	1700		V _{GE} = 0V, V _{CE} = 600V, T _J = 150°C
V _{FM}	Diode Forward Voltage Drop	—	1.4	1.7	V	I _C = 8.0A
		—	1.3	1.6		I _C = 8.0A, T _J = 150°C
I _{GES}	Gate-to-Emitter Leakage Current	—	—	±100	nA	V _{GE} = ±20V

Switching Characteristics @ T_J = 25°C (unless otherwise specified)

	Parameter	Min.	Typ.	Max.	Units	Conditions
Q _g	Total Gate Charge (turn-on)	—	27	40	nC	I _C = 9.0A
Q _{ge}	Gate - Emitter Charge (turn-on)	—	4.2	6.2		V _{CC} = 400V
Q _{gc}	Gate - Collector Charge (turn-on)	—	9.9	15		V _{GE} = 15V
t _{d(on)}	Turn-On Delay Time	—	43	—	ns	T _J = 25°C
t _r	Rise Time	—	20	—		I _C = 9.0A, V _{CC} = 480V
t _{d(off)}	Turn-Off Delay Time	—	240	360		V _{GE} = 15V, R _G = 50Ω
t _f	Fall Time	—	150	220		Energy losses include "tail" and diode reverse recovery.
E _{on}	Turn-On Switching Loss	—	0.25	—	mJ	See Fig. 9, 10, 18
E _{off}	Turn-Off Switching Loss	—	0.64	—		
E _{ts}	Total Switching Loss	—	0.89	1.3		
t _{d(on)}	Turn-On Delay Time	—	41	—	ns	T _J = 150°C, See Fig. 11, 18
t _r	Rise Time	—	22	—		I _C = 9.0A, V _{CC} = 480V
t _{d(off)}	Turn-Off Delay Time	—	320	—		V _{GE} = 15V, R _G = 50Ω
t _f	Fall Time	—	290	—		Energy losses include "tail" and diode reverse recovery.
E _{ts}	Total Switching Loss	—	1.35	—	mJ	
L _E	Internal Emitter Inductance	—	7.5	—	nH	Measured 5mm from package
C _{ies}	Input Capacitance	—	540	—	pF	V _{GE} = 0V
C _{oes}	Output Capacitance	—	37	—		V _{CC} = 30V
C _{res}	Reverse Transfer Capacitance	—	7.0	—		f = 1.0MHz
t _{rr}	Diode Reverse Recovery Time	—	37	55	ns	T _J = 25°C See Fig. 14
		—	55	90		T _J = 125°C
I _{rr}	Diode Peak Reverse Recovery Current	—	3.5	5.0	A	T _J = 25°C See Fig. 15
		—	4.5	8.0		T _J = 125°C
Q _{rr}	Diode Reverse Recovery Charge	—	65	138	nC	T _J = 25°C See Fig. 16
		—	124	360		T _J = 125°C
di _{(rec)M/dt}	Diode Peak Rate of Fall of Recovery During t _b	—	240	—	A/μs	T _J = 25°C See Fig. 17
		—	210	—		T _J = 125°C

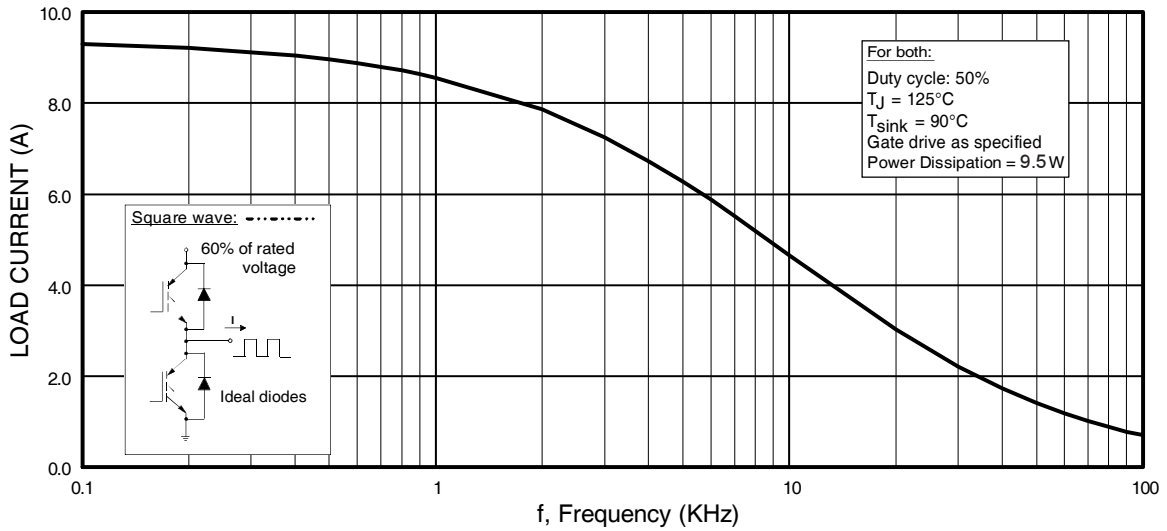

Fig. 1 - Typical Load Current vs. Frequency
(Load Current = I_{RMS} of fundamental)

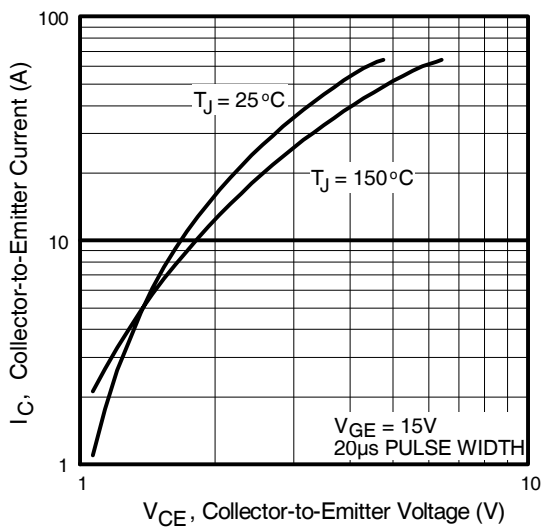

Fig. 2 - Typical Output Characteristics
www.irf.com

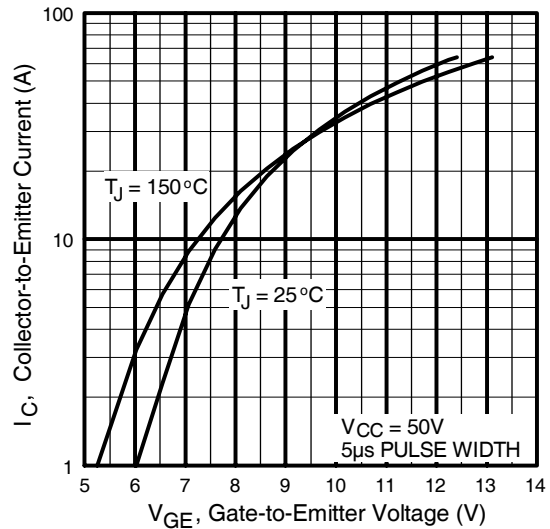

Fig. 3 - Typical Transfer Characteristics

IRG4IBC20FDPbF

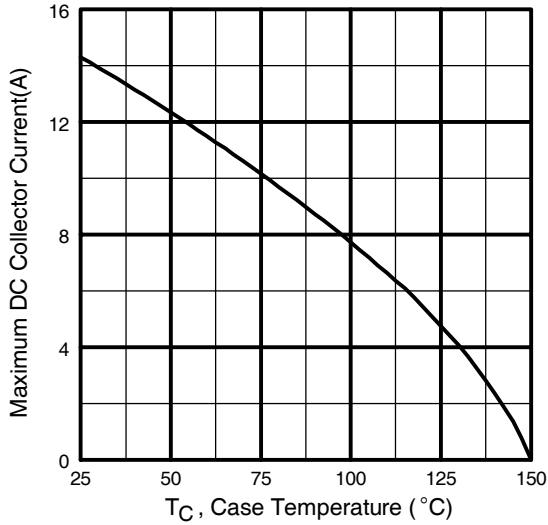

Fig. 4 - Maximum Collector Current vs. Case Temperature

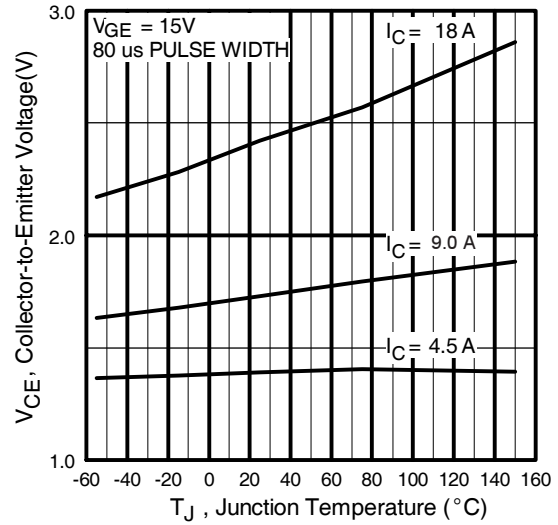

Fig. 5 - Typical Collector-to-Emitter Voltage vs. Junction Temperature

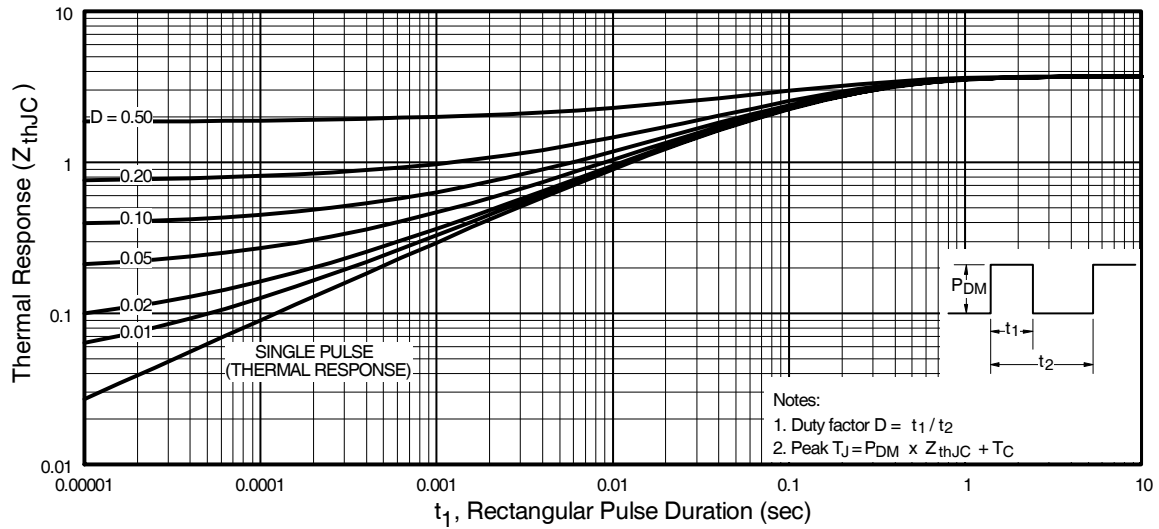

Fig. 6 - Maximum Effective Transient Thermal Impedance, Junction-to-Case

IRG4IBC20FDPbF

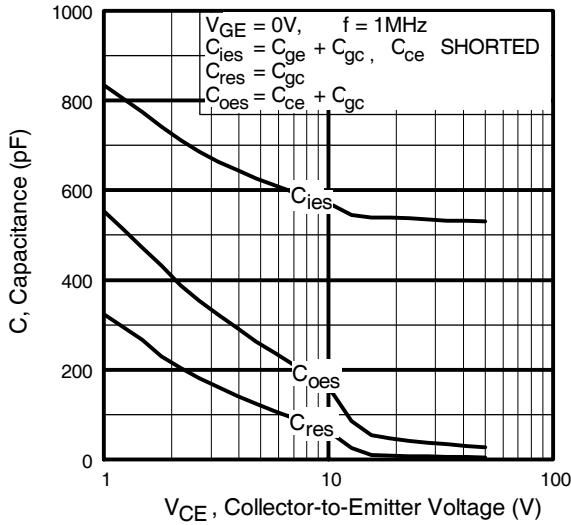

Fig. 7 - Typical Capacitance vs. Collector-to-Emitter Voltage

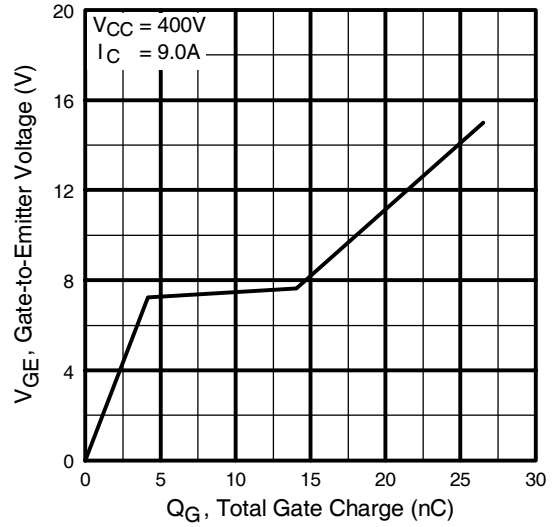

Fig. 8 - Typical Gate Charge vs. Gate-to-Emitter Voltage

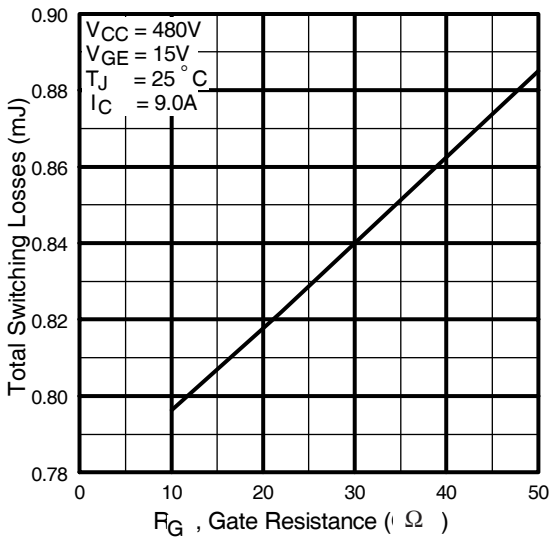

Fig. 9 - Typical Switching Losses vs. Gate Resistance

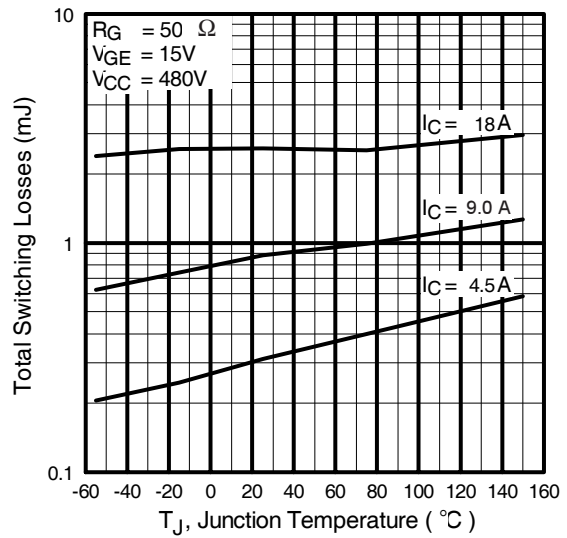

Fig. 10 - Typical Switching Losses vs. Junction Temperature

IRG4IBC20FDPbF

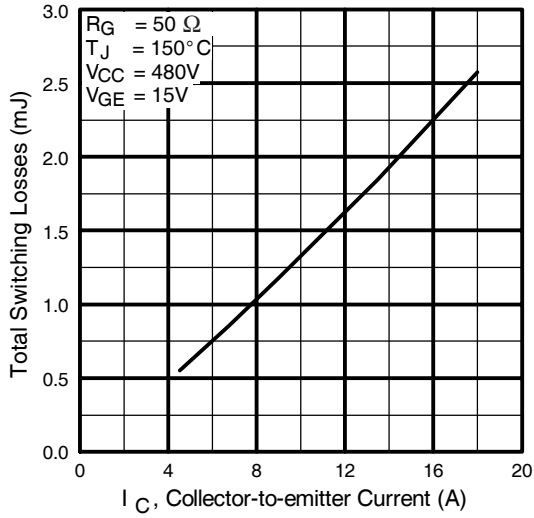

Fig. 11 - Typical Switching Losses vs. Collector-to-Emitter Current

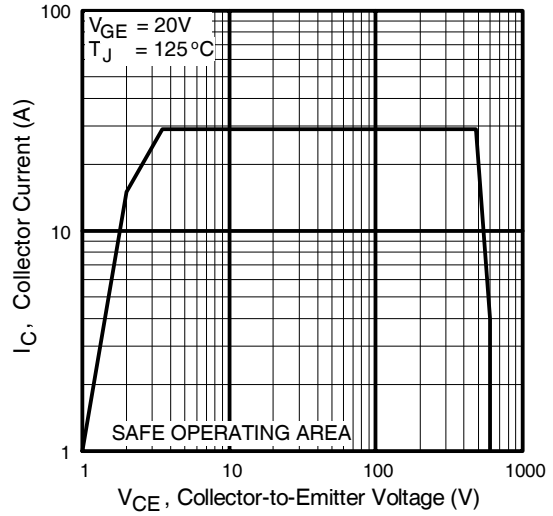

Fig. 12 - Turn-Off SOA

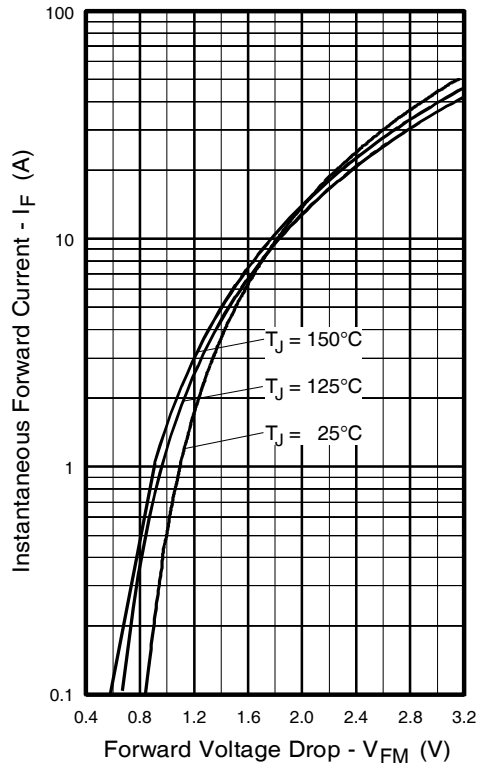

Fig. 13 - Maximum Forward Voltage Drop vs. Instantaneous Forward Current

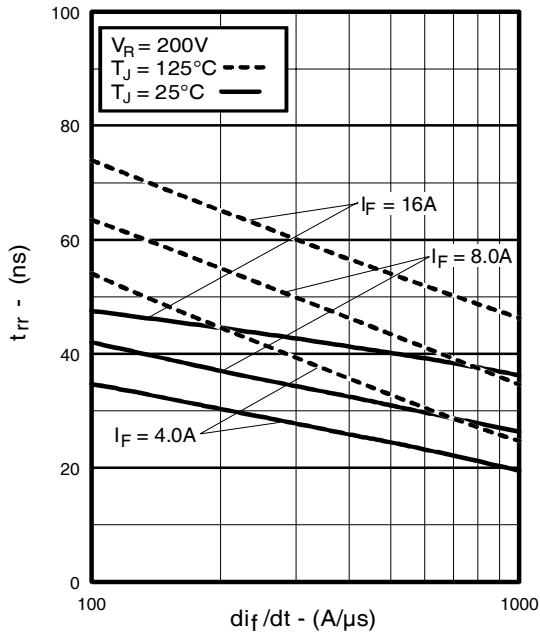

Fig. 14 - Typical Reverse Recovery vs. di_f/dt

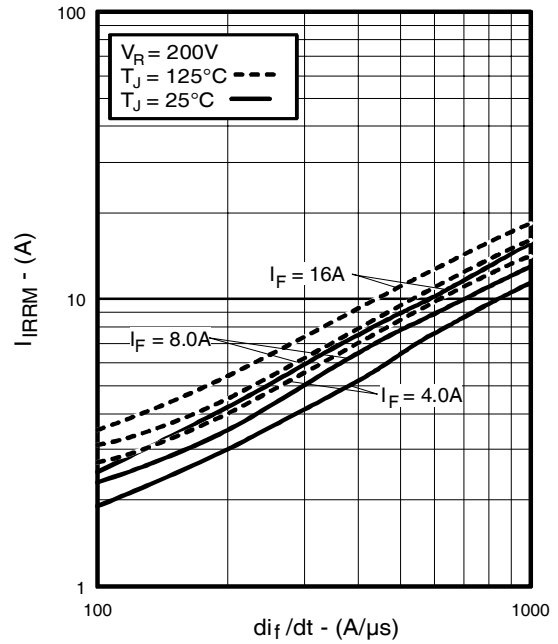

Fig. 15 - Typical Recovery Current vs. di_f/dt

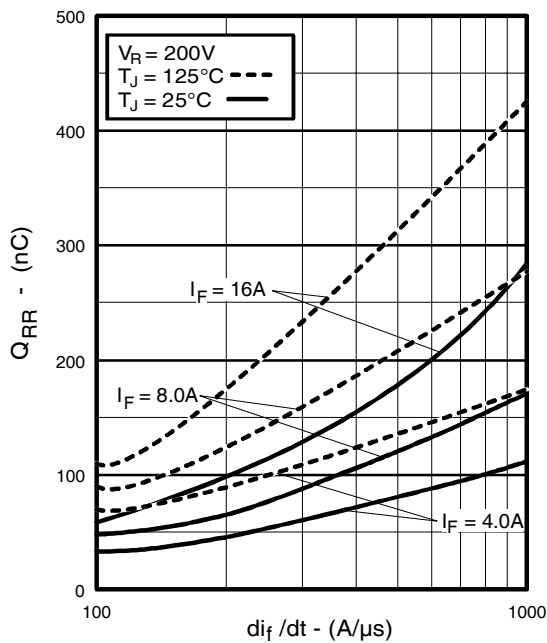

Fig. 16 - Typical Stored Charge vs. di_f/dt
www.irf.com

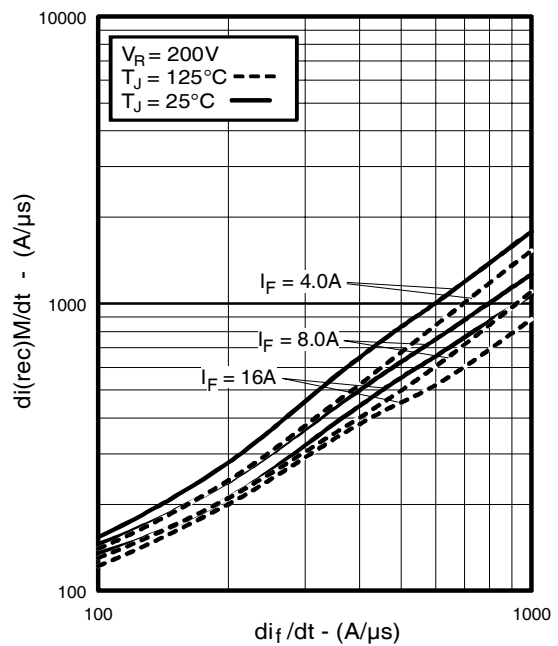

Fig. 17 - Typical $di_{(rec)M}/dt$ vs. di_f/dt

IRG4IBC20FDPbF

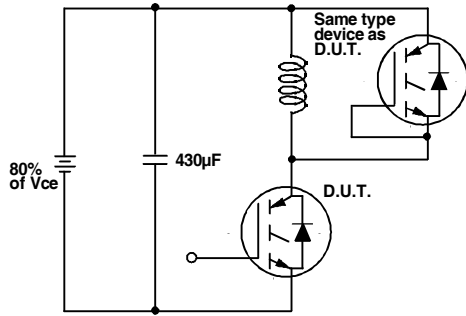

Fig. 18a - Test Circuit for Measurement of I_{LM} , E_{on} , $E_{off}(\text{diode})$, t_{rr} , Q_{rr} , I_{rr} , $t_{d(on)}$, t_r , $t_{d(off)}$, t_f

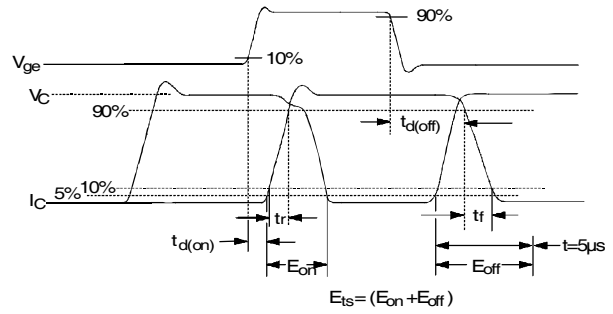

Fig. 18b - Test Waveforms for Circuit of Fig. 18a, Defining E_{off} , $t_{d(off)}$, t_f

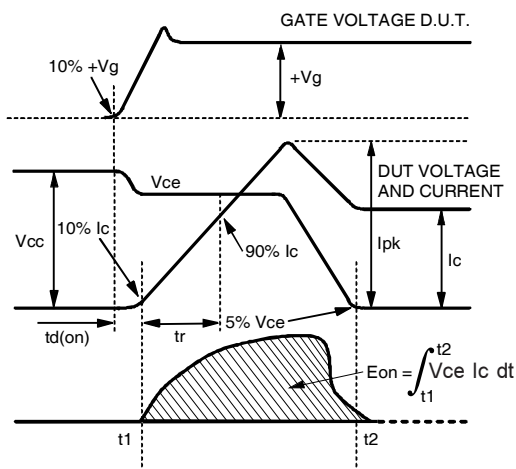

Fig. 18c - Test Waveforms for Circuit of Fig. 18a, Defining E_{on} , $t_{d(on)}$, t_r

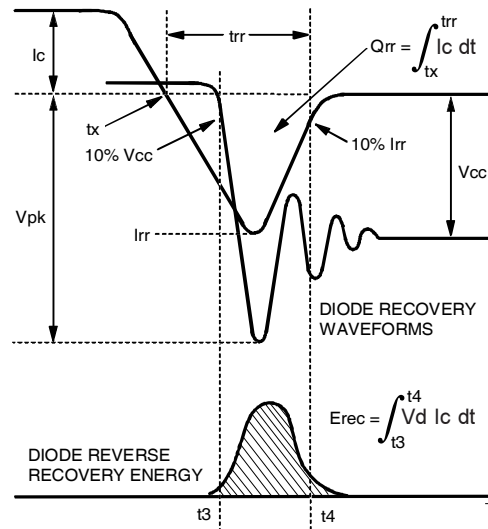

Fig. 18d - Test Waveforms for Circuit of Fig. 18a, Defining E_{rec} , t_{rr} , Q_{rr} , I_{rr}

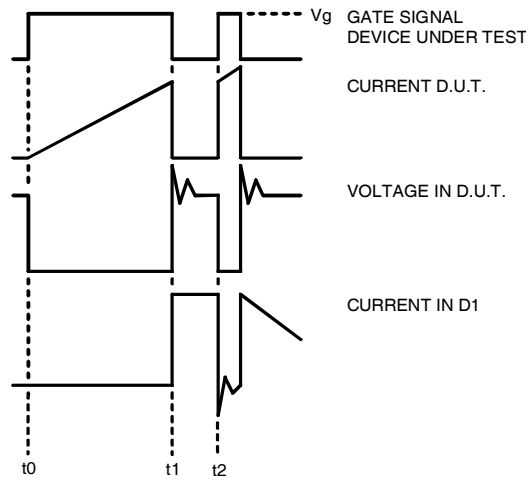

Figure 18e. Macro Waveforms for Figure 18a's Test Circuit

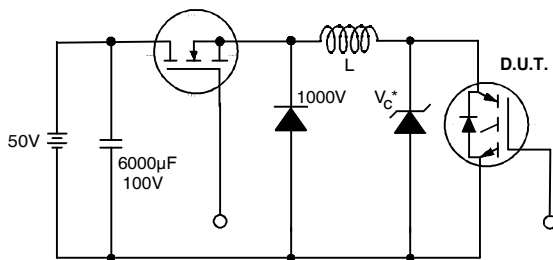

Figure 19. Clamped Inductive Load Test Circuit

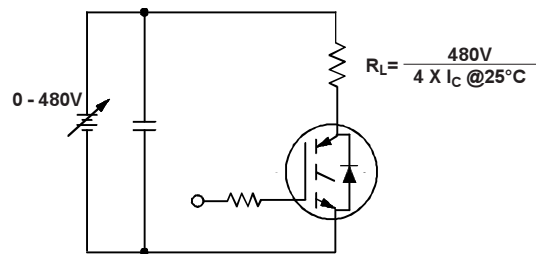

Figure 20. Pulsed Collector Current Test Circuit

IRG4IBC20FDPbF

Notes:

- ① Repetitive rating: $V_{GE}=20V$; pulse width limited by maximum junction temperature (figure 20)
- ② $V_{CC}=80\%(V_{CES})$, $V_{GE}=20V$, $L=10\mu H$, $R_G = 50\Omega$ (figure 19)
- ③ Pulse width $\leq 80\mu s$; duty factor $\leq 0.1\%$.
- ④ Pulse width $5.0\mu s$, single shot.
- ⑤ $t = 60s$, $f = 60Hz$

TO-220 Full-Pak Package Outline

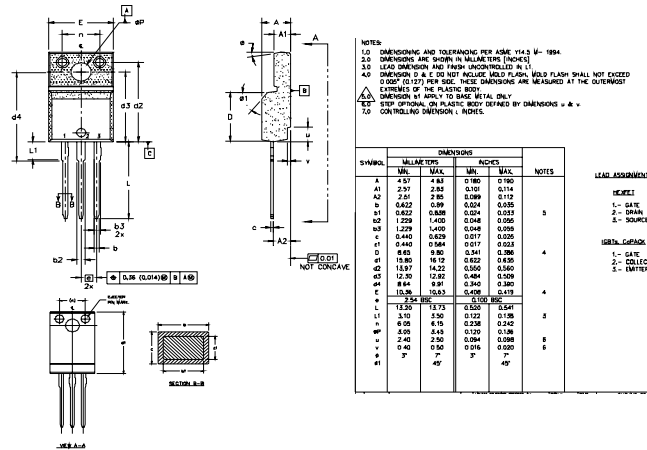

TO-220 Full-Pak Part Marking Information

EXAMPLE: THIS IS AN IRF1840G
 WITH ASSEMBLY
 LOT CODE 3432
 ASSEMBLED ON WW 24 1999
 IN THE ASSEMBLY LINE "K"
Note: "P" in assembly line
 position indicates "Lead-Free"

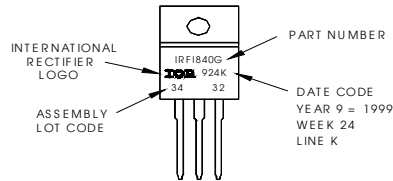

Data and specifications subject to change without notice.

Note: For the most current drawings please refer to the IR website at:
<http://www.irf.com/package/>